

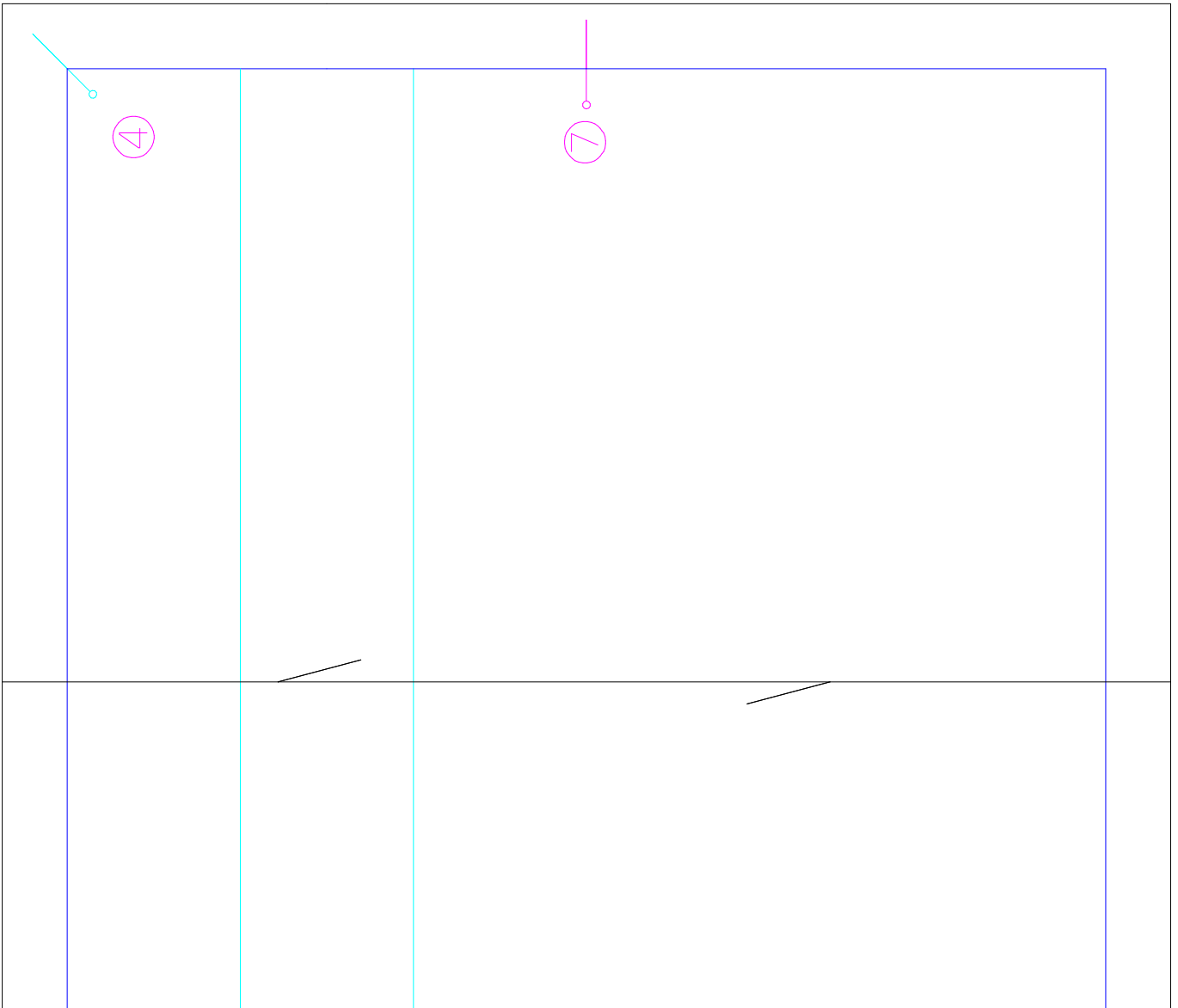

- | | |
|---|---|
| 1 | 2 |
| 3 | 4 |
| 5 | 6 |
| 7 | |



3分の2~4分の3程度長さのゴムを入れる

ジャージの型紙改造パーツ
そで口
伸びない生地で作る場合
左右対称に2枚
婦人M
Letter jacket
Cuffs
×2

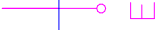
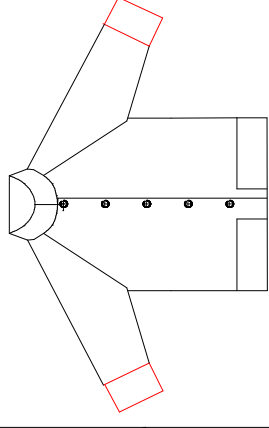

⑤

3分の2~4分の3程度長さのゴムを入れる

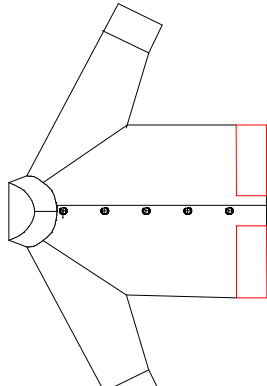

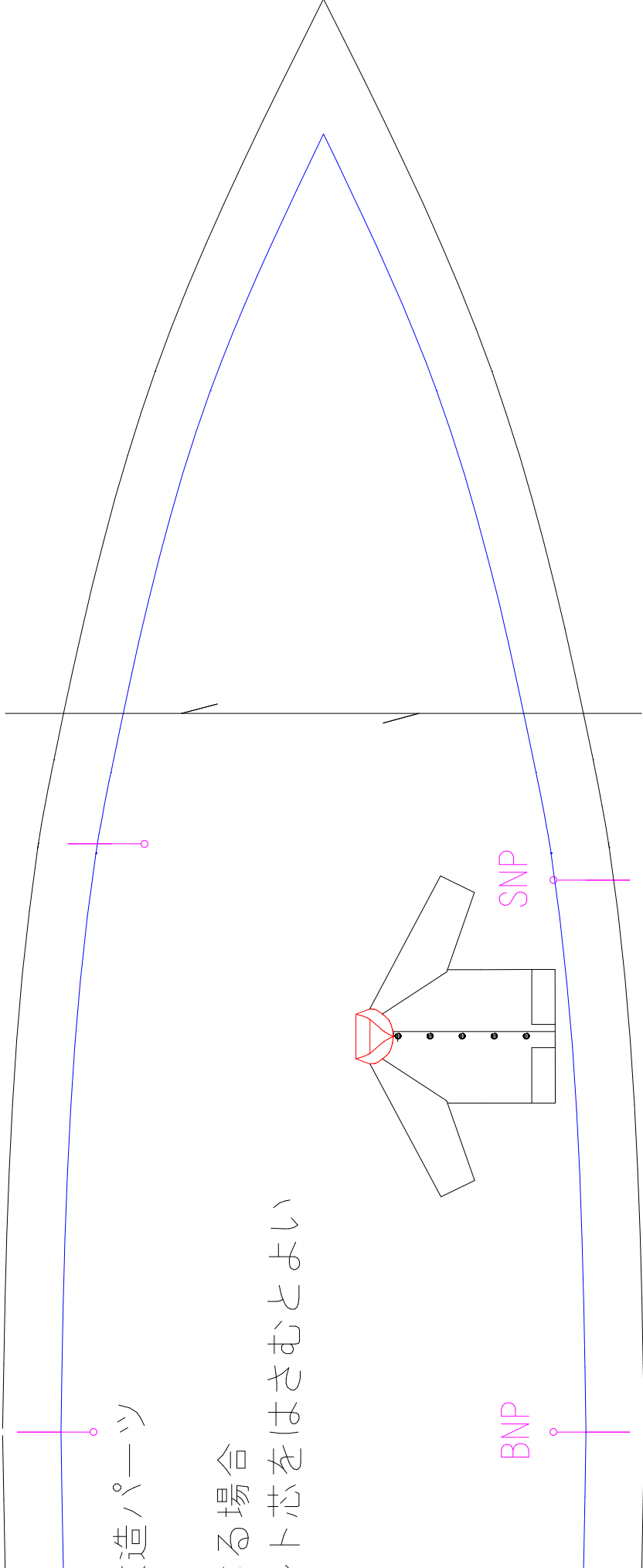

造パーツ

る場合
ト芯をはさむとよい

SNP

BNP

⑥

⑤

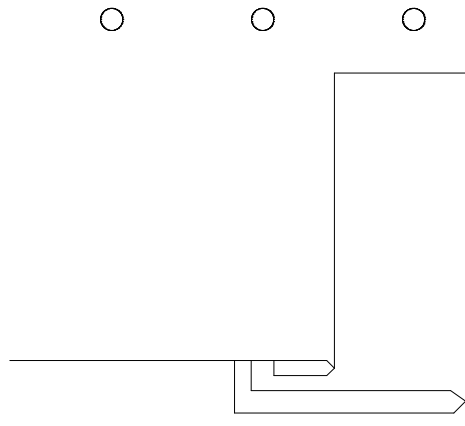

こんな感じで二つ折りして使ってね

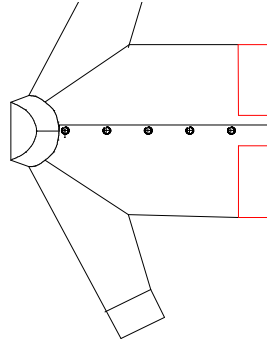

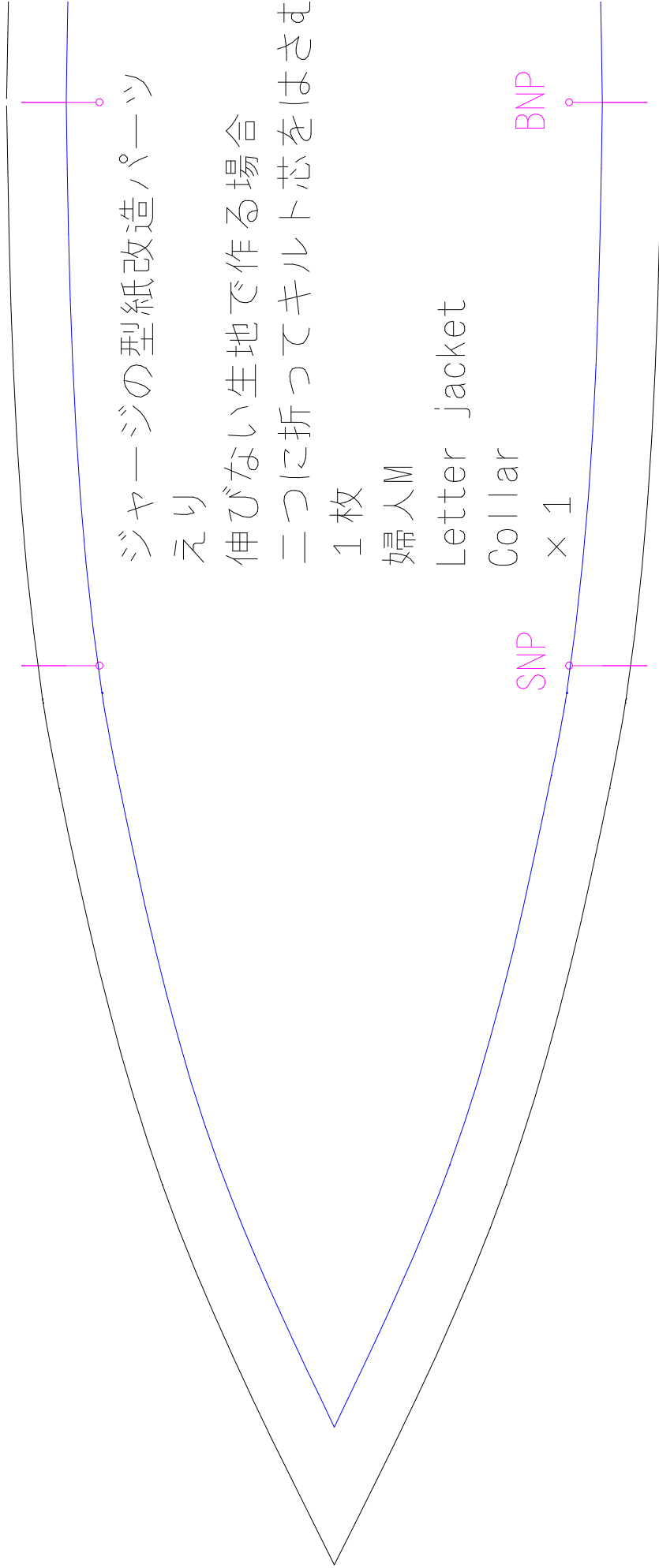

<7>

⑤

④

⑦

ジャージ・スタジヤン
すそパーツ
伸びない生地で作る場合
1枚
婦人M
Letter jacket
Hem
× 1